

Serie 57000

New  57000 Pag. 3.7	 57010 Pag. 3.7	New  57020 Pag. 3.8	New  57030 Pag. 3.8	New  57040 Pag. 3.8	 57050 Pag. 3.9	 57055 Pag. 3.9	 57465 Pag. 3.9	 57060 Pag. 3.9
 57100 Pag. 3.10	 57106 Pag. 3.10	New  57111 Pag. 3.10	New  57116 Pag. 3.11	 57126 Pag. 3.11	New  57130 Pag. 3.11	 57200 Pag. 3.12	New  57211 Pag. 3.12	New  57216 Pag. 3.12
 57223 Pag. 3.13	 57226 Pag. 3.13	New  57230 Pag. 3.13	 57310 Pag. 3.14	 57326 Pag. 3.14	 57500 Pag. 3.14	 57510 Pag. 3.14	 57550 Pag. 3.15	 57560 Pag. 3.15
 51410 Pag. 3.15	 51420 Pag. 3.16	 51430 Pag. 3.16	 51440 Pag. 3.16	New  50600 Pag. 3.16	 57610 Pag. 3.17	 50625 Pag. 3.17	New  57700 Pag. 3.17	 57800 Pag. 3.17
 55801 Pag. 3.18	 55802 Pag. 3.18	 50980 Pag. 3.19	 50990 Pag. 3.19	 50006 Pag. 3.19				

RACCORDI AUTOMATICI METALLICI

METALLIC PUSH-IN FITTINGS

VOLLMETALL STECKVERSCHRAUBUNGEN

RACCORDS INSTANTANÉS TOUT LAITON NICKELÈ

RACORDAJE AUTOMÁTICO METÁLICO

CONEXÕES PUSH-IN METÁLICAS

57000

Serie 57000



Con la serie 57.000, Aignep risponde alle esigenze del mercato "Heavy Duty" in maniera appropriata. Completamente in ottone nichelato, questa serie offre prestazioni elevate in termini di robustezza uniche sul mercato.

Le applicazioni più "difficili e pesanti", sono ben supportate da questa serie che hanno ottime performance in termine applicativo anche in presenza di vibrazioni, abrasioni e/o scintille di saldatura.

Principali vantaggi

- Connessione e sconnessione istantanea
- Pieno passaggio e tenuta al vuoto grazie a guarnizioni sagomate
- Tre tipologie di filettature, BSPP, BSPT (Universal short) e Metrica
- Alta Resistenza e robustezza integralmente realizzati in metallo
- Vasta gamma a disposizione per soddisfare le installazioni più esigenti
- Versione EPDM (-40 °C)
- Silicon Free

Applicazioni

- Robotica
- Automotive e Saldatura
- Industria pesante, settore ferroviario
- Circuiti aria compressa
- Acqua di raffreddamento
- Vuoto
- Glicole con EPDM

The 57.000 series is oriented to the "Heavy Duty" market.

This full metal solution offers robust and high performances.

Mainly used in environments with strong vibrations, abrasions and welding sparks.

Main advantages

- Quick connection and disconnection
- Full Flow and Vacuum resistant tank to special shaped seals
- 3 threads available, BSPP, BSPT (universal short) & Metric
- Robust and Resistant
- Large range to satisfy extreme applications
- EPDM (-40 °C) version on demand
- Silicon Free

Applications

- Robotics
- Automotive e Welding
- Heavy Industry, Railways
- Compressed air Circuit
- Cooling water
- Vacuum
- Glycol with EPDM

Die 57.000-Serie ist auf den "Heavy Duty" Markt orientiert. Diese Vollmetall-Lösung ist robust und bietet hohe Leistungen.

Wird vor allem in Umgebungen mit starken Vibrationen, Abrieb und Schweißfunken verwendet.

Hauptvorteile

- Schnelle Verbindung und Trennung
- Voller Durchfluss und Vakuumfestigkeit, dank spezieller Formdichtungen
- Drei Gewindearten, BSPP, BSPT (universal kurz) und metrisch
- Robust und widerstandsfähig
- Grosses Sortiment um extreme Einsätze zu erfüllen
- EPDM (-40 °C) Version auf Anfrage
- Silikonfrei

Anwendungen

- Robotik
- Automobil-Industrie und Schweißen
- Schwerindustrie, Eisenbahnen

Avec la série 57000, Aignep répond aux besoins du marché "Heavy Duty". Entièrement en laiton nickelé, cette série offre des performances élevées et une parfaite robustesse.

Parfaitement adaptée pour les environnements sévères tels que vibrations, abrasions, et pour les zones de soudage (projection d'étincelles).

Principaux avantages

- Connexion et déconnexion instantanée
- Plein débit et tenue au vide grâce à des joints de forme
- Trois types de filetages, BSPP, BSPT (Universal court) et métriques
- Haute résistance et robustesse
- Large gamme disponible pour répondre aux installations les plus exigeantes
- EPDM (-40 °C) version sur demande
- Sans silicone

Applications

- Robotique
- Automobile et soudage
- Industrie lourde, secteur ferroviaire
- Circuits d'air comprimé
- Eau de refroidissement, vide
- Glycol avec joint EPDM

Con la serie 57.000, Aignep responde a las necesidades del mercado "Heavy Duty" de forma apropiada. Completamente de latón niquelado, esta serie ofrece un alto rendimiento en términos de robustez sin igual en la industria.

Las aplicaciones más "difíciles y pesadas", están bien soportadas por esta serie que tiene un gran rendimiento, incluso en presencia de vibraciones, abrasiones y/o chispas de soldadura.

Principales ventajas

- Conexión y desconexión instantánea
- Paso total y estanqueidad al vacío gracias a las juntas moldeadas
- Tres tipos de roscas, BSPP, BSPT (universal short) y métricas
- Alta resistencia y robustez integralmente realizado en metal
- Amplia gama disponible para satisfacerlas instalaciones más exigentes
- Versión en EPDM (-40 °C)
- Libre de sílicona

Aplicaciones

- Robótica
- Automoción y soldadura
- La industria pesada, sector ferroviario
- Circuitos de aire comprimido
- Agua de refrigeración, vacío
- Glicol con EPDM

A série 57.000 é direcionada ao mercado "Heavy Duty". Esta conexão "full metal" oferece robustez e alta performance.

Aplicada principalmente em ambientes com fortes vibrações, abrasão e projeções de solda.

Principais vantagens

- Rápida conexão e desconexão
- Vazão total e resistência ao vácuo graças ao design de suas vedações
- 3 tipos de rosca disponíveis: BSPP, BSPT (universal short) & Métrica.
- Robustez e Resistência
- Grande range de itens para satisfazer a aplicações extremas
- Versão em EPDM (-40 °C) sob encomenda
- Livre de Silicone

Aplicações

- Robótica
- Automotiva e solda
- Indústria pesada e ferroviária
- Circuitos de ar comprimido
- Água de resfriamento, vácuo
- Glicol com EPDM



CARATTERISTICHE TECNICHE
 TECHNICAL CHARACTERISTICS
 TECHNISCHE ANGABEN
 CARACTÉRISTIQUES TECHNIQUES
 CARACTERÍSTICAS TÉCNICAS
 CARACTERÍSTICAS TÉCNICAS



Norma di Riferimento
 Reference standard
 Entspricht der Norm
 Norme de référence
 Normativa de referencia
 Norma de referência

1907/2006

REACH

2011/65/CE

RoHS

PED

2014/68/UE

ISO
14743:2004

SILICON
FREE

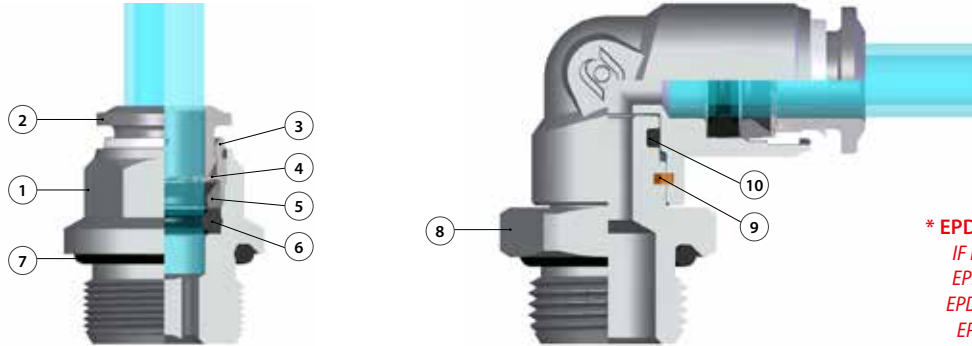

*** EPDM A RICHIESTA**
 IF REQUESTED EPDM
 EPDM AUF ANFRAGE
 EPDM SUR DEMANDE
 EPDM BAJO PEDIDO
 EPDM SOB ENCOMENDA

Materiali e Componenti

IT

- 1 Corpo in ottone nichelato
- 2 Spintore sgancio tubo in Ottone nichelato
- 3 Capsula in ottone nichelato
- 4 Pinza d'aggraffaggio in acciaio inox AISI 301
- 5 Anello di posizionamento in tecnopolimero
- 6 Guarnizione sagomata in NBR (EPDM a richiesta)
- 7 Guarnizione filetto in NBR (EPDM a richiesta)
- 8 Basetta Filettata in Ottone Nichelato
- 9 Seeger
- 10 Guarnizione in NBR (EPDM a richiesta)

Component Parts and Materials

GB

- 1 Nickel-plated brass Body
- 2 Nickel-plated brass Collet
- 3 Nickel-plated brass Capsule
- 4 Steel AISI 301 Clamping washer
- 5 Technopolymeric positioning ring
- 6 NBR Molded seal (if requested EPDM)
- 7 NBR Thread packing (if requested EPDM)
- 8 Base Threaded Nickel Plated Brass
- 9 Seeger
- 10 NBR seal (if requested EPDM)

Komponenten und Materialien

DE

- 1 Körper Messing vernickelt
- 2 Rohr Lösering Messing vernickelt
- 3 Haltering Messing vernickelt
- 4 Zahnscheibe Edelstahl AISI 301
- 5 Positioniererring Technopolymer
- 6 Lippendichtung NBR (EPDM auf Anfrage)
- 7 Gewindeabdichtung NBR (EPDM auf Anfrage)
- 8 Gewindebasis Messing vernickelt
- 9 Seeger
- 10 Lippendichtung NBR (EPDM auf Anfrage)

Matériaux et Composants

FR

- 1 Corps: Laiton nickelé
- 2 Pousoir: Laiton nickelé
- 3 Capsule de retenue: Laiton nickelé
- 4 Rondelle d'accrochage: AISI 301
- 5 Anneau de positionnement: Technopolymère
- 6 Joint à lèvres: NBR (EPDM sur demande)
- 7 Joint d'étanchéité du filetage: NBR (EPDM sur demande)
- 8 Bague de sécurité en laiton nickelé
- 9 Seeger
- 10 Joint en NBR (EPDM sur demande)

Materiales y Componentes

ES

- 1 Cuerpo en latón niquelado
- 2 Anillo de extracción tubo en latón niquelado
- 3 Cápsula en latón niquelado
- 4 Pinza de agarre en acero inox AISI 301
- 5 Anillo de posicionamiento en tecnopolímero
- 6 Junta de forma en NBR (EPDM bajo pedido)
- 7 Junta rosca en NBR (EPDM bajo pedido)
- 8 Base rosca en latón niquelado
- 9 Seeger
- 10 Junta en NBR (EPDM bajo pedido)

Materiais e Componentes

PT

- 1 Corpo em latão niquelado
- 2 Anilha de liberação em latão niquelado
- 3 Cápsula de latão niquelado
- 4 Pinça de travamento em aço-inox AISI 301
- 5 Anel de posicionamento em tecnopolímero
- 6 Vedação em NBR (EPDM sob encomenda)
- 7 Vedação da rosca em NBR (EPDM sob encomenda)
- 8 Base rosca em latão niquelado
- 9 Seeger
- 10 Vedação em NBR (EPDM sob encomenda)



Pressioni

Pressures

Druckbereich

Pressions

Presiones

Pressões

- 0.99 bar (-0.099 MPa)

20 bar (2.0 MPa)



Fluidi compatibili

Aria compressa / Vuoto / Acqua / Vapore (EPDM)

Fluids

Compressed air / Vacuum / Water / Steam (EPDM)

Geeignete Medien

Druckluft / Vakuum / Wasser / Dampf (EPDM)

Fluides compatibles

Air comprimé / Vide / Eau / Vapeur (EPDM)

Fluidos compatibles

Aire comprimido / Vacío / Agua / Vapor (EPDM)

Fluidos compatíveis

Ar comprimido / Vácuo / Água / Vapor (EPDM)



Temperature

Temperatures

Temperatur

Températures

Temperaturas

Temperaturas

- 20 °C

+ 80 °C



Tubi di Collegamento

IT

Tubi in materiale plastico:
 PA6, PA11, PA12, Polietilene, *Poliuretano, PTFE, FEP.
 *Per tubi in Poliuretano è consigliata una durezza di 98 shore.

Connection Tubes

GB

Plastic tubes:
 PA6, PA11, PA12, Polyethylene, *Polyurethane, PTFE, FEP.
 *For Polyurethane hoses it is required a minimum hardness of 98 shore.

Geeignete Rohre

DE

Kunststoffrohre:
 PA6, PA11, PA12, Polyethylene, *Polyurethan, PTFE, FEP.
 *Für Polyurethan Rohre ist eine Härte von 98 Shore empfohlen.

Tubes Conseillés

FR

Tubes plastiques:
 PA6, PA11, PA12, Polyéthylène, *Polyuréthane, PTFE, FEP.
 *Pour les tubes en polyuréthane, il est conseillé une dureté de 98 Shore.

Tubos de Conexión

ES

Tubos en material plástico:
 PA6, PA11, PA 12, Polietileno, *Poliuretano, PTFE, FEP.
 *Para tubos en poliuretano es aconsejada una durezza de 98 shore.

Tubos de Conexão

PT

Tubos em material plástico:
 PA6, PA11, PA12, Polietileno, *Poliuretano, PTFE, FEP.
 *Para tubos em Poliuretano é requerida uma durezza de 98 shore.



Filettatura Gas conica "UNIVERSAL SHORT". Gas conica conforme ISO 7.1, BS 21, DIN 2999. Gas cilindrica conforme ISO 228 Classe A. Metrica conforme ISO R/262.	IT	Threads "UNIVERSAL SHORT" Tapered thread. Tapered gas in conformity with ISO 7.1, BS 21, DIN 2999. Parallel gas in conformity with ISO 228 Class A. Metric in conformity with ISO R/262.	GB	Gewindearten Konisches Gewinde "UNIVERSAL SHORT". Konisches Gewinde nach Norm ISO 7.1, BS 21, DIN 2999. Zylindrisches Gewinde nach Norm ISO 228 Classe A. Metrisches Gewinde nach Norm ISO R/262.	DE
Filetages Filetage conique "UNIVERSAL SHORT". Filetage conique conforme: ISO 7.1, BS 21, DIN 2999. Filetage cylindrique conforme: ISO 228 Class A. Filetage métrique conforme: ISO R/262.	FR	Roscas Gas cónica "UNIVERSAL SHORT". Gas cónica conforme ISO 7.1, BS 21, DIN 2999. Gas cilíndrica conforme ISO 228 Clase A. Métrica conforme ISO R/262.	ES	Roscas Gas cónica "UNIVERSAL SHORT". Gas cónica conforme ISO 7.1, BS 21, DIN 2999. Gas paralela conforme ISO 228 Classe A. Métrica conforme ISO R/262.	PT



UNIVERSAL SHORT

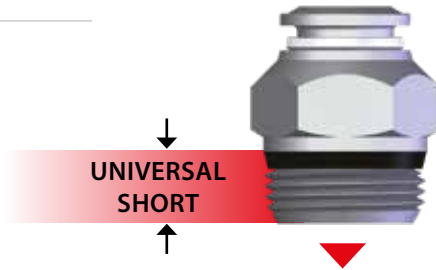

<p>NPT NPTF</p> <ul style="list-style-type: none"> Conica Tapered Konisch Conique Cónica Cônica 	<p>ISO 7 BSPP</p> <ul style="list-style-type: none"> Cilindrica Parallell Zylindrisch Cylindrique Cilíndrica Paralela 	<p>ISO 7 BSPT PT</p> <ul style="list-style-type: none"> Conica Tapered Konisch Conique Cónica Cônica 	<p>ISO 228 BSP PF</p> <ul style="list-style-type: none"> Cilindrica Parallell Zylindrisch Cylindrique Cilíndrica Paralela
---	---	---	--

"UNIVERSAL SHORT" La filettatura conica "UNIVERSAL SHORT" è progettata per soddisfare le seguenti caratteristiche: <ul style="list-style-type: none"> • ridurre la lunghezza d'ingombro; • ridurre la chiave rispetto ad alcuni raccordi con filettature cilindriche; • consentire l'accoppiamento con diversi standard di filettature femmina sia coniche che cilindriche. 	IT	"UNIVERSAL SHORT" The "UNIVERSAL SHORT" taper thread has been designed to offer the following advantages to the users: <ul style="list-style-type: none"> • reduced overall length; • smaller hex dimensions compared to the parallel threads; • to allow the assembly with different female threads both taper as well as parallel. 	GB	"UNIVERSAL SHORT" Das konische Gewinde "UNIVERSAL SHORT" ist so konzipiert, dass folgende Vorteile erzielt werden: <ul style="list-style-type: none"> • Reduzierung der Länge des Gewindes - kürzere Montagezeit; • Reduzierung der Schlüsselweite im Vergleich von Verschraubungen mit zylindrischen Gewinden - geringerer Lochabstand; • Ermöglicht den Einsatz in verschiedene Gewindearten, sowie in konische- und zylindrische Innengewinde. 	DE
"UNIVERSAL SHORT" Le filetage conique "UNIVERSAL SHORT" a été conçu pour satisfaire les exigences suivantes: <ul style="list-style-type: none"> • réduire la longueur d'encombrement; • réduire les dimensions hexagonales par rapport au filetage cylindrique; • permettre le montage avec divers taraudages standards soit coniques soit cylindriques. 	FR	"UNIVERSAL SHORT" La rosca cónica "UNIVERSAL SHORT" ha sido proyectada para satisfacer las siguientes características: <ul style="list-style-type: none"> • reducir la longitud; • reducir la llave respecto a algunos racores con rosca cilíndrica; • permitir el acoplamiento con diferentes standard de rosas hembra sean cónicas o cilíndricas. 	ES	"UNIVERSAL SHORT" A rosca cónica "UNIVERSAL SHORT" é projetada para satisfazer às seguintes características: <ul style="list-style-type: none"> • reduzir o comprimento da conexão; • reduzir o dimensional com relação às rosas paralelas; • permitir o acoplamento da conexão a diferentes tipos de rosca fêmea, sejam elas cónicas ou paralelas. 	PT



Consentire una completa tenuta anche su superfici non perfettamente piane, concave, convesse o inclinate, con diversi smussi o raggi.	IT	To ensure the right tightening also with surfaces not perfectly flat, without spot-facing, concave convex and with different kinds of chamfers or radius.	GB	Eine vollständige Abdichtung ist auch auf unebenen Flächen, wie geneigt, konkav oder konvex und mit unterschiedlichen Radien oder Fasen gewährleistet.	DE
Pour permettre une parfaite étanchéité même sur des surfaces non planes, concaves, convexas ou inclinées et avec différents chanfreins ou rayons.	FR	Consentir una completa estanqueidad incluso en superficies no perfectamente planas, cóncavas, convexas o inclinadas, con diferentes ángulos o radios.	ES	Permite um aperto correto em superfícies não perfeitamente planas, côncavas, convexas ou inclinadas, com diferentes chanfros ou raios.	PT



Coppia di serraggio

Torque specifications

Angaben Drehmoment

Couple de serrage

Par de apriete

Especificações de Torque



ISO 228



"UNIVERSAL SHORT"

I valori di rottura possono variare in base all'articolo
Breaking values may vary according to the item
 Die maximal werte dienen nur zu informationszwecken
Les valeurs maximales sont présentées à titre indicatif
 Los valores de rotura pueden variar en función del artículo
Los valores de força pode variar em função artigo

MISURA MEASURE GRÖSSE DIMENSIONS MEDIDA MEDIDA	COPPIA CONSIGLIATA Nm RECOMMENDED TORQUE Nm EMPFOHLENES DREHMOMENT Nm COUPLE DE SERRAGE Nm PAR ACONSEJADO Nm TORQUE RECOMENDADO Nm	COPPIA DI ROTTURA Nm BREAKING TORQUE Nm ABSCHERDREHMOMENT Nm COUPLE DE RUPTURE Nm PAR DE ROTURA Nm BINÁRIO ROMPER Nm
M5	0,8	3,2
M7	3	8
M8	3	8
1/8	3	8
1/4	9	30
3/8	10	60
1/2	12	50

MISURA MEASURE GRÖSSE DIMENSIONS MEDIDA MEDIDA	COPPIA MINIMA CONSIGLIATA Nm RECOMMENDED MINIMUM TORQUE Nm EMPFOHLENES DREHMOMENT Nm COUPLE DE SERRAGE Nm PAR MÍNIMO ACONSEJADO Nm TORQUE MÍNIMO RECOMENDADO Nm	COPPIA MASSIMA CONSIGLIATA Nm RECOMMENDED MAX TORQUE Nm ABSCHERDREHMOMENT Nm COUPLE DE RUPTURE Nm PAR MÁXIMO ACONSEJADO Nm TORQUE MÁXIMA RECOMENDADO Nm
1/8	5	7
1/4	5	7
3/8	5	7
1/2	5	7

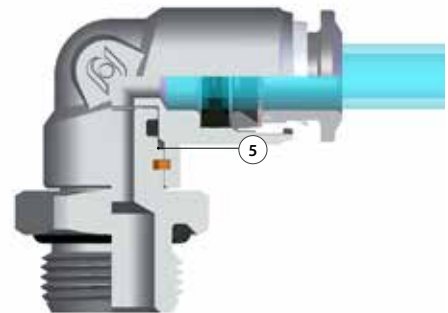
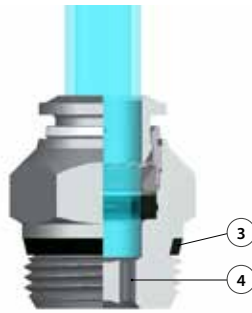
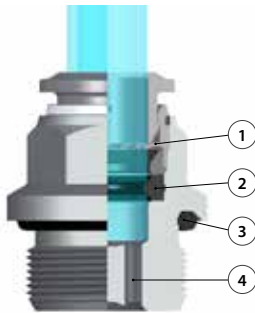

Vantaggi

IT

- 1 La pinza in acciaio inox garantisce il perfetto aggancio di tubi di qualsiasi materiale senza danneggiarne la superficie. Il collegamento tra tubo e raccordo assicura una tenuta totale anche in condizioni di urti e vibrazioni.
- 2 La particolare geometria della guarnizione permette inoltre l'utilizzo dei raccordi anche con il vuoto.
- 3 Tutte le filettature di questa serie sono state dotate di elementi di tenuta che permettono l'immediato utilizzo dei raccordi riducendo notevolmente i tempi di installazione.
- 4 Tutti i raccordi dritti possono essere montati anche con chiave esagonale ed è possibile utilizzarli anche in spazi molto ridotti.
- 5 Raccordo orientabile con anello di sicurezza interno. Garantisce maggiore durata alla rotazione e trazione.

Advantages

GB

- 1 The washer is made in stainless steel ensures the perfect tube clamping with every kinds of materials without damage the surface. The connection between the tube and the fitting ensure a total tightness even in severe conditions such as impact and vibrations.
- 2 The particular geometric shape of the seal ensure the perfect tightness even with vacuum.
- 3 All of threads from this range have been equipped with tightening parts which allow the direct assembly of the fittings, reducing the installation time.
- 4 All the straight fittings can be assembled also with Allen wrench and it is possible to use them in reduced spaces.
- 5 Orienting fitting with safety ring inside. Improved durability to the rotation and traction.

Vorteile

DE

- 1 Konisches Gewinde "kurz" Die Zahnscheibe sorgt für eine perfekte Halterung des Rohres ohne die Oberfläche zu beschädigen. Die Dichtigkeit zwischen Rohr und Verschraubung ist auch bei Erschütterungen und Vibrationen gewährleistet.
- 2 Die besondere Geometrie der Dichtung ermöglicht auch die Anwendung der Verschraubungen in Verbindung mit Vakuum.
- 3 Alle Verschraubungen in dieser Serie sind mit Gewindeabdichtungen ausgestattet, die den sofortigen Einsatz ermöglichen und daher die Montagezeit stark reduzieren.
- 4 Alle geraden Verschraubungen können auch mit Inbusschlüsseln montiert werden, daher kleiner Lochabstand möglich.
- 5 Flexible Montage mit Sicherungsring innen. Verbesserte Beständigkeit gegenüber der Drehung und Traktions.

Avantages

FR

- 1 La rondelle en acier inoxydable garantit la parfaite tenue du tube quelle que soit la matière et sans l'endommager. La connexion entre le tube et le raccord assure une étanchéité totale même dans des conditions d'impact ou de vibrations.
- 2 La spécificité géométrique du joint permet l'utilisation des raccords avec le vide.
- 3 Tous les filetages de cette série sont équipés d'éléments d'étanchéité qui permettent l'utilisation immédiate des raccords réduisant ainsi le temps d'installation.
- 4 Tous les raccords droits peuvent être aussi montés avec une clé hexagonale pour permettre une utilisation dans des espaces réduits.
- 5 Accessoire de fixation réglable avec anneau de sécurité à l'intérieur. Amélioration de la durée de la rotation et de traction.

Ventajas

ES

- 1 La pinza en acero inox garantiza el perfecto agarre del tubo de cualquier material sin perjudicar la superficie. La conexión entre tubo y racor asegura una estanqueidad total aun en condiciones de impacto o vibración.
- 2 La particular geometría de la junta garantiza una perfecta estanqueidad incluso en vacío.
- 3 Todas las rosas de esta serie están fabricadas con junta de cierre que permite la inmediata utilización del racor reduciendo notablemente el tiempo de instalación.
- 4 Todos los racores rectos pueden montarse también con llave hexagonal y es posible utilizarlos incluso en espacios muy reducidos.
- 5 Montaje ajustable con sistema de seguridad interior. La mejora de la durabilidad a la rotación y tracción.

Vantagens

PT

- 1 A pinça em aço-inox garante o perfeito travamento do tubo de qualquer material sem danificar a superfície do mesmo. A conexão entre o tubo e a conexão assegura uma vedação total também em condições de impactos e vibrações.
- 2 A geometria particular da vedação permite a utilização da conexão também para aplicações com vácuo.
- 3 Todas as rosas desta série são dotadas de elementos de vedação, o que permite a imediata utilização das conexões, reduzindo notavelmente o tempo de instalação.
- 4 Todas as conexões retas podem ser montadas também com chave allenando possível montagem das mesmas em espaços bem reduzidos.
- 5 Montagem ajustável com anel de segurança dentro. A durabilidade melhorada para a rotação e tração.



Articoli in comune con serie 89000 per tubi pollici - Items in common with series 89000 for inch tubes
 Gleicher Artikel wie in Serie 89000 für Zoll Rohre - Article identique avec la série 89000 pour tube en pouce
 Artículos en común con la serie 89000 para tubos en pulgadas - Código em comum com a série 89000 para tubos em polegada

57000

New

RACCORDO DIRITTO MASCHIO "UNIVERSAL SHORT"

STRAIGHT MALE ADAPTOR "UNIVERSAL SHORT"
 GERADE EINSCHRAUBVERSCHRAUBUNG KONISCH "UNIVERSAL SHORT"
 RACCORD DROIT MÂLE, CONIQUE "UNIVERSAL SHORT"
 RACOR RECTO MACHO CÓNICO "UNIVERSAL SHORT"
 CONEXÃO RETA COM ROSCA "UNIVERSAL SHORT"

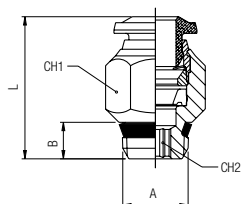

Code	Tube	A	B	L	CH1	CH2	Pack.
* 89000 00 003	4 (5/32)	1/8	5.5	18	11	3	10
* 89000 00 004	4 (5/32)	1/4	7	19	14	3	10
57000 00 011	5	1/8	5.5	20	11	4	10
57000 00 002	6	1/8	5.5	21.5	13	4	10
57000 00 003	6	1/4	7	21	14	4	10
57000 00 014	6	3/8	7.5	23	17	4	10
57000 00 015	6	1/2	9	23.5	21	4	10
* 89000 00 008	8 (5/16)	1/8	5.5	24.5	14	5	10
* 89000 00 009	8 (5/16)	1/4	7	22	14	6	10
* 89000 00 010	8 (5/16)	3/8	7.5	23	17	6	10
* 89000 00 022	8 (5/16)	1/2	9	23.5	21	6	10
57000 00 007	10	1/4	7	28	17	7	10
57000 00 008	10	3/8	7.5	25.5	17	8	10
57000 00 017	10	1/2	9	26	21	8	10
57000 00 009	12	1/4	7	31.5	20	7	10
57000 00 010	12	3/8	7.5	29.5	20	9	10
57000 00 018	12	1/2	9	31.5	21	10	10
57000 00 019	14	3/8	7.5	32.5	21	9	10
57000 00 020	14	1/2	9	31.5	21	10	10
57000 00 021	16	3/8	7.5	35.5	23	10	10
57000 00 022	16	1/2	9	36.5	25	12	10

57010

RACCORDO DIRITTO MASCHIO ESAGONO INCASSATO

STRAIGHT MALE ADAPTOR WITH EXAGON EMBEDDED
 GERADE EINSCHRAUBVERSCHRAUBUNG MIT INNENSECHSKANT
 RACCORD DROIT MÂLE, CONIQUE, 6-PANS INTERIEUR
 RACOR RECTO MACHO CÓNICO HEXÁGONO INTERIOR
 CONEXÃO RETA COM SEXTAVADO INTERNO

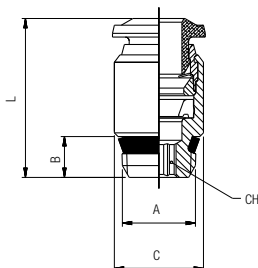

Code	Tube	A	B	C	L	CH	Pack.
* 89010 00 001	4 (5/32)	1/8	7.5	11	19	3	10
57010 00 003	6	1/8	7.5	12	22.5	4	10
57010 00 004	6	1/4	11	14	24.5	4	10
* 89010 00 002	8 (5/16)	1/8	7.5	14	25.5	5	10
* 89010 00 003	8 (5/16)	1/4	11	14	25	6	10

57010

RACCORDO DIRITTO MASCHIO CILINDRICO ESAGONO INCASSATO

STRAIGHT MALE ADAPTOR (PARALLEL) WITH EXAGON EMBEDDED
 GERADE EINSCHRAUBVERSCHRAUBUNG MIT INNENSECHSKANT ZYLINDRISCH
 RACCORD DROIT MÂLE, CYLINDRIQUE, 6-PANS INTERIEUR
 RACOR RECTO MACHO CILÍNDRICO CON TÓRICA HEXÁGONO INTERIOR
 CONEXÃO RETA COM SEXTAVADO INTERNO E ROSCA MÉTRICA

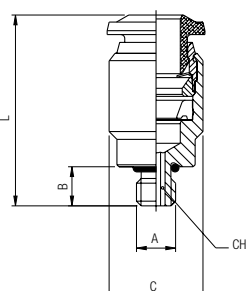

Code	Tube	A	B	C	L	CH	Pack.
57010 00 001	4	M5	3.6	10	21	2.5	10
57010 00 009	4	M7x1	4.8	10	21	2.5	10
57010 00 007	6	M5	3.6	12	24.5	2.5	10

57020

New

RACCORDO DIRITTO MASCHIO CILINDRICO

STRAIGHT MALE ADAPTOR (PARALLEL)
GERADE EINSCHRAUBVERSCHAUBUNG ZYLINDRISCH
RACCORD DROIT MÂLE, CYLINDRIQUE
RACOR RECTO MACHO CILÍNDRICO CON TÓRICA
CONEXÃO RETA COM ROSCA PARALELA

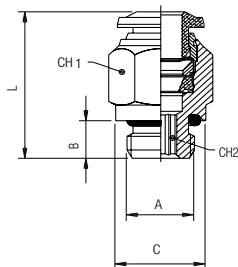

Code	Tube	A	B	C	L	CH1	CH2	Pack.
57020 00 001	4	M5	3.6	8	21	10	2	10
57020 00 002	4	1/8	5.4	13	20	10	3	10
57020 00 022	4	1/4	7.1	16	19.5	16	3	10
57020 00 041	4	3/8	8.1	20	18	20	3	10
57020 00 018	5	M5	3.6	8	23.5	12	2	10
57020 00 019	5	1/8	5.4	13	22	12	4	10
57020 00 020	6	M5	3.6	10	24.5	13	2	10
57020 00 003	6	1/8	5.4	13	23.5	13	4	10
57020 00 004	6	1/4	7.1	16	23.5	13	4	10
57020 00 027	6	3/8	8.1	20	25	13	4	10
57020 00 028	6	1/2	9.6	25	27	13	4	10
57020 00 005	8	1/8	5.4	13	25	14	5	10
57020 00 006	8	1/4	7.1	16	23	14	6	10
57020 00 007	8	3/8	8.1	20	24	14	6	10
57020 00 029	8	1/2	9.6	25	26.5	14	6	10
57020 00 008	10	1/4	7.1	16	30.5	17	6	10
57020 00 009	10	3/8	8.1	20	27.5	17	8	10
57020 00 031	10	1/2	9.6	25	27	17	8	10
57020 00 032	12	1/4	7.1	16	34.5	20	6	10
57020 00 011	12	3/8	8.1	20	34	20	8	10
57020 00 023	12	1/2	9.6	25	31	22	10	10
57020 00 024	14	3/8	8.1	20	35	21	10	10
57020 00 025	14	1/2	9.6	25	32	22	11	10
57020 00 042	16	3/8	8.1	20	36.5	23	10	10
57020 00 043	16	1/2	9.6	25	37.5	25	12	10
57020 00 046	4	M6x1	5.4	12	18.5	10	3	10
57020 00 033	4	M8x1	5.4	12	18.5	10	3	10
57020 00 037	6	M8x1	5.4	12	24.5	13	3	10
57020 00 038	6	M10x1	5.4	13	23	13	4	10
57020 00 012	6	M12x1	7.3	15	23.5	13	4	10
57020 00 013	6	M12x1.25	7.3	15	23.5	13	4	10
57020 00 014	6	M12x1.5	7.3	15	23.5	13	4	10
57020 00 039	8	M8x1	5.4	12	25.5	14	4	10
57020 00 040	8	M10x1	5.4	13	25.5	14	4	10
57020 00 017	8	M12x1.5	7.3	15	27.5	14	6	10

57030

New

RACCORDO DIRITTO FEMMINA

STRAIGHT FEMALE ADAPTOR
AUF SCHRAUBVERSCHAUBUNG
RACCORD DROIT, TARAUDE
RACOR RECTO HEMBRA
CONEXÃO RETA COM ROSCA FÊMEA

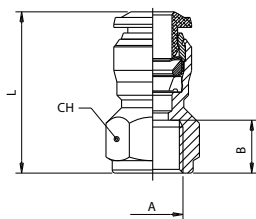

Code	Tube	A	B	L	CH	Pack.
57030 00 008	4	M5	5.5	21	11	10
57030 00 001	4	1/8	8.5	24	13	10
57030 00 009	4	1/4	11	27.5	16	10
57030 00 006	5	1/8	8.5	26.5	13	10
57030 00 002	6	1/8	8.5	26	13	10
57030 00 003	6	1/4	11	29.5	16	10
57030 00 004	8	1/8	8.5	27	15	10
57030 00 005	8	1/4	11	29.5	17	10
57030 00 010	8	3/8	12	32	19	10
57030 00 011	10	1/4	11	32	18	10
57030 00 012	10	3/8	12	33.5	19	10
57030 00 013	10	1/2	15	39	24	10
57030 00 014	12	3/8	12	36	21	10
57030 00 015	12	1/2	15	41	24	10
57030 00 016	16	3/8	12	41	24	10
57030 00 017	16	1/2	15	42	24	10

57040

New

RACCORDO DIRITTO INTERMEDIO

STRAIGHT CONNECTOR
VERBINDUNGSVERSCHAUBUNG
RACCORD UNION DOUBLE
RACOR RECTO INTERMEDIO
CONEXÃO RETA TUBO-TUBO

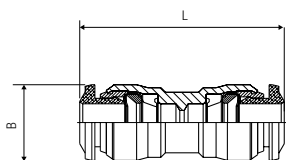

Code	Tube	Tube	L	B	Pack.
* 57040 00 001	4 (5/32)	4 (5/32)	30.5	10.5	10
57040 00 008	5	5	33	11.5	10
57040 00 002	6	4	32	12.5	10
57040 00 003	6	6	34	12.5	10
57040 00 004	8	6	35	14.5	10
* 57040 00 005	8 (5/16)	8 (5/16)	36	14.5	10
57040 00 011	10	8	40.5	17.5	10
57040 00 006	10	10	42	17.5	10
57040 00 012	12	10	45.5	20.5	10
57040 00 007	12	12	47	20.5	10
57040 00 010	14	14	49	21.5	10
57040 00 013	16	16	54.5	24	10

57050

RACCORDO DIRITTO INTERMEDIO DI ATTRAVERSAMENTO

BULKHEAD CONNECTOR
 SCHOTTVERSCHRAUBUNG
 RACCORD TRAVERSÉE DE CLOISON
 RACOR RECTO INTERMEDIO PASATABIQUES
 CONEXÃO PASSA-MURO RETA TUBO-TUBO

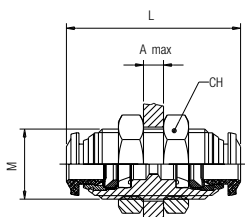

Code	Tube	M	L	CH	A max	Pack.
* 57050 00 001	4 (5/32)	M12x1	31.5	17	7	10
57050 00 006	5	M14x1	33	17	7	10
57050 00 002	6	M14x1	35	17	9.5	10
57050 00 009	8-6	M16x1	37	19	10.5	10
* 57050 00 003	8 (5/16)	M16x1	37	19	10.5	10
57050 00 010	10-6	M20x1	43	24	11.5	10
57050 00 011	10-8	M20x1	43	24	12.5	10
57050 00 004	10	M20x1	43	24	12.5	10
57050 00 005	12	M22x1	48	26	16.5	10

57055

RACCORDO DIRITTO DI ATTRAVERSAMENTO FEMMINA

FEMALE BULKHEAD CONNECTOR
 SCHOTTVERSCHRAUBUNG INNENGEWINDE
 TRAVERSÉE DE CLOISON FEMELLE
 RACOR RECTO INTERMEDIO PASATABIQUES HEMBRA
 CONEXAO PASSA-MURO RETA FEMEA

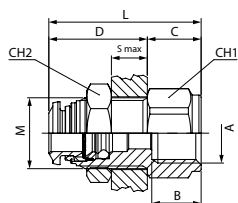

Code	Tube	A	B	M	S max	CH1	CH2	C	D	L	Pack.
57055 00 001	4	1/8	8.5	M12X1	7	15	17	10	19	29	10
57055 00 002	6	1/8	8.5	M14X1	8	16	17	10	21	31	10
57055 00 003	6	1/4	11	M14X1	8	16	17	12	21	33	10
57055 00 004	8	1/8	8.5	M16X1	8	18	19	10	22	32	10
57055 00 005	8	1/4	11	M16X1	8	18	19	12	22	34	10
57055 00 006	10	3/8	12	M20X1	9.5	24	24	14	25.5	39.5	10
57055 00 007	12	3/8	12	M22X1	10.5	24	26	15	27.5	42.5	10
57055 00 008	12	1/2	15	M22X1	10.5	24	26	17	27.5	44.5	10

57465

ADATTATORE DIRITTO INTERMEDIO DI ATTRAVERSAMENTO

BULKHEAD CONNECTOR
 SCHOTTVERSCHRAUBUNG
 ADAPTEUR DROIT TRAVERSEE DE CLOISON
 RACOR RECTO INTERMEDIO PASATABIQUES
 CONEXAO PASSA-MURO RETA TUBO-TUBO

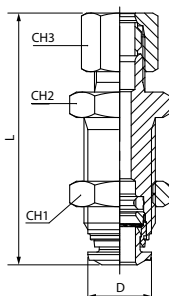

Code	Tube	L	D	CH1	CH2	CH3	Pack.
57465 00 002	6	49.5	12.5	13	17	17	10
57465 00 003	8	52	14	14	19	19	10
57465 00 004	10	59	17	19	24	24	10

57060

RACCORDO A L ORIENTABILE INTERMEDIO DI ATTRAVERSAMENTO

BULKHEAD ORIENTING ELBOW
 WINKEL-SCHOTTVERSCHRAUBUNG (DREHBAR)
 RACCORD EQUERRE ORIENTABLE A TRAVERSEE DE CLOISON
 RACOR A L ORIENTABLE INTERMEDIO PASATABIQUES
 CONEXÃO PASSA-MURO EM "L" ORIENTÁVEL

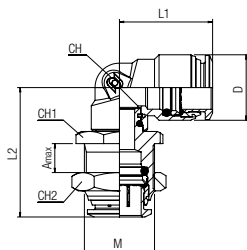

Code	Tube	M	L1	L2	CH	CH1	CH2	Amax	D	Pack.
* 57060 00 003	4 (5/32)	M12x1	17.5	26	9	14	17	6	10	10
57060 00 004	6	M14x1	21.5	31	11	16	17	6.5	12.5	10
* 57060 00 005	8 (5/16)	M16x1	22	34	12	18	19	6.5	14.5	10
57060 00 006	10	M20x1	26.5	36	14	22	24	7.5	17.5	10
57060 00 007	12	M22x1	30.5	43	16	24	26	9	21.5	10
57060 00 008	14	M23x1	30.5	43	16	25	27	9.5	21.5	10

57100

RACCORDO A L MASCHIO CONICO

ELBOW MALE ADAPTOR (TAPER)

WINKELVERSCHRAUBUNG KONISCH (NICHT DREHBAR)

EQUERRE NON ORIENTABLE MÂLE, CONIQUE (COURT)

RACOR A L MACHO CÔNICO

CONEXÃO MACHO EM "L" COM ROSCA CÔNICA

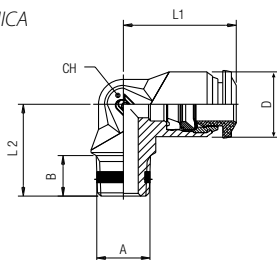

Code	Tube	A	B	L1	L2	CH	D	Pack.
57100 00 001	4	M5	5	17	15	9	10	10
57100 00 002	4	1/8	7.5	17	15.5	9	10	10
57100 00 010	5	M5	5	20	17	11	12.5	10
57100 00 011	5	1/8	7.5	20	17.5	11	12.5	10
57100 00 003	6	1/8	7.5	21	17.5	11	12.5	10
57100 00 012	6	1/4	11	21	21.5	11	12.5	10
57100 00 004	8	1/8	7.5	22.5	19	13	14	10
57100 00 005	8	1/4	11	22.5	21.5	13	14	10
57100 00 006	10	1/4	11	26.5	24.5	16	17	10
57100 00 007	10	3/8	11.5	26.5	24	16	17	10
57100 00 008	12	1/4	11	30.5	28	19	21.5	10
57100 00 009	12	3/8	11.5	30.5	28	19	21.5	10

57106

RACCORDO A L ORIENTABILE FEMMINA

ORIENTING ELBOW FEMALE ADAPTOR

AUFSCHRAUB-WINKELSCHRAUBUNG (DREHBAR)

EQUERRE ORIENTABLE, FEMELLE

RACOR A L ORIENTABLE HEMBRA

CONEXÃO EM "L" ORIENTÁVEL COM ROSCA FÊMEA

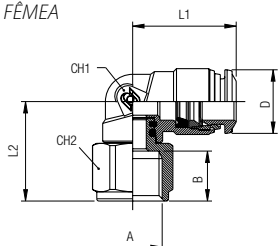

Code	Tube	A	B	L1	L2	CH1	CH2	D	Pack.
57106 00 001	4	1/8	8.5	18	20	9	13	10	10
57106 00 002	4	1/4	11	18	21.5	9	16	10	10
57106 00 003	6	1/8	8.5	21	20.5	11	13	12.5	10
57106 00 004	6	1/4	11	21	23	11	16	12.5	10
57106 00 005	8	1/8	8.5	22.5	20.5	12	13	14.5	10
57106 00 006	8	1/4	11	22.5	23	12	16	14.5	10
57106 00 009	10	1/4	11	26.5	25	14	19	17	10
57106 00 010	10	3/8	12	26.5	28	14	19	17	10
57106 00 011	12	1/2	15	31.5	34.5	16	24	20	10

57111

New

RACCORDO A L ORIENTABILE MASCHIO "UNIVERSAL SHORT"

ORIENTING ELBOW MALE ADAPTOR "UNIVERSAL SHORT"

WINKELVERSCHRAUBUNG KONISCH (DREHBAR) "UNIVERSAL SHORT"

EQUERRE ORIENTABLE MÂLE, CONIQUE "UNIVERSAL SHORT"

RACOR A L ORIENTABLE MACHO "UNIVERSAL SHORT"

CONEXÃO MACHO EM "L" ORIENTÁVEL COM ROSCA "UNIVERSAL SHORT"

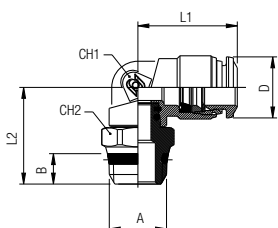

Code	Tube	A	B	L1	L2	CH1	CH2	D	Pack.
* 89111 00 003	4 (5/32)	1/8	5.5	18	19.5	9	13	10	10
* 89111 00 004	4 (5/32)	1/4	7	18	21	9	15	10	10
57111 00 004	6	1/8	5.5	21	21.5	11	13	12.5	10
57111 00 005	6	1/4	7	21	23	11	15	12.5	10
* 89111 00 008	8 (5/16)	1/8	5.5	22.5	22.5	12	13	14.5	10
* 89111 00 009	8 (5/16)	1/4	7	22.5	22.5	12	15	14.5	10
* 89111 00 010	8 (5/16)	3/8	7.5	22.5	23	12	17	14.5	10
* 89111 00 018	8 (5/16)	1/2	9	22.5	25.5	12	21	14.5	10
57111 00 010	10	1/4	7	26.5	26.5	14	16	17.5	10
57111 00 011	10	3/8	7.5	26.5	24.5	14	17	17.5	10
57111 00 012	10	1/2	9	26.5	27	14	21	17.5	10
57111 00 013	12	3/8	7.5	31.5	26.5	16	20	21.5	10
57111 00 014	12	1/2	9	31.5	29	16	21	21.5	10
57111 00 015	14	3/8	7.5	31.5	27	16	20	21.5	10
57111 00 016	14	1/2	9	31.5	29.5	16	21	21.5	10
57111 00 017	16	3/8	7.5	33.5	41.5	19	25	24	10
57111 00 018	16	1/2	9	33.5	43	19	25	24	10

57116

New

RACCORDO A L ORIENTABILE MASCHIO CILINDRICO

ORIENTING ELBOW MALE ADAPTOR (PARALLEL)

WINKELVERSCHRAUBUNG ZYLINDRISCH (DREHBAR)

EQUERRE ORIENTABLE MÂLE, CYLINDRIQUE

RACOR A L ORIENTABLE MACHO CILÍNDRICO CON TÓRICA

CONEXÃO MACHO EM "L" ORIENTÁVEL COM ROSCA PARALELA

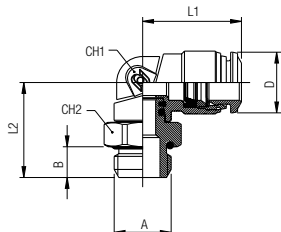

Code	Tube	A	B	L1	L2	CH1	CH2	D	Pack.
57116 00 002	4	M5	3.5	18	17.5	9	8	10	10
57116 00 003	4	1/8	5.5	18	18	9	13	10	10
57116 00 004	4	1/4	7	18	18	9	16	10	10
57116 00 005	5	M5	3.5	20	20	11	11	12.5	10
57116 00 006	5	1/8	5.5	20	20	11	13	12.5	10
57116 00 007	6	M5	3.5	21	20	11	11	12.5	10
57116 00 008	6	1/8	5.5	21	20	11	13	12.5	10
57116 00 009	6	1/4	7	21	21.5	11	16	12.5	10
57116 00 030	6	3/8	7	21	21.5	11	16	12.5	10
57116 00 010	8	1/8	5.5	22.5	21	12	13	14.5	10
57116 00 011	8	1/4	7	22.5	21.5	12	16	14.5	10
57116 00 012	8	3/8	8	22.5	23.5	12	20	14.5	10
57116 00 013	8	1/2	9.5	22.5	25	12	25	14.5	10
57116 00 014	10	1/4	7	26.5	25.5	14	16	17.5	10
57116 00 015	10	3/8	8	26.5	25	14	20	17.5	10
57116 00 016	10	1/2	9.5	26.5	26.5	14	25	17.5	10
57116 00 025	12	1/4	8	31.5	27.5	16	20	21.5	10
57116 00 017	12	3/8	8	31.5	27	16	20	21.5	10
57116 00 018	12	1/2	9.5	31.5	28.5	16	25	21.5	10
57116 00 019	14	3/8	8	31.5	27.5	16	20	21.5	10
57116 00 020	14	1/2	9.5	31.5	29	16	25	21.5	10
57116 00 031	16	3/8	8.1	33.5	40	19	25	24	10
57116 00 032	16	1/2	9.6	33.5	41.5	19	25	24	10
57116 00 026	4	M6x1	3.5	17.5	18	9	8	10	10
57116 00 027	4	M8x1	5.5	17.5	18	9	12	10	10
57116 00 028	6	M10x1	7	21	21.5	11	13	12	10
57116 00 021	6	M12x1	7.5	20	22	11	16	12.5	10
57116 00 022	6	M12x1.25	7.5	20	22	11	16	12.5	10
57116 00 023	6	M12x1.5	7.5	20	22	11	16	12.5	10
57116 00 024	8	M12x1.5	7.5	22.5	22	12	16	14.5	10

57126

RACCORDO A L ORIENTABILE PROLUNGATO MASCHIO CILINDRICO

EXTENDED ORIENTING ELBOW MALE ADAPTOR (PARALLEL)

VERLÄNGERTE WINKELVERSCHRAUBUNG ZYLINDRISCH (DREHBAR)

EQUERRE PROLONGÉE ORIENTABLE MÂLE, CYLINDRIQUE

RACOR A L ORIENTABLE PROLONGADO MACHO CILÍNDRICO CON TÓRICA

CONEXÃO MACHO EM "L" PROLONGADO COM ROSCA PARALELA

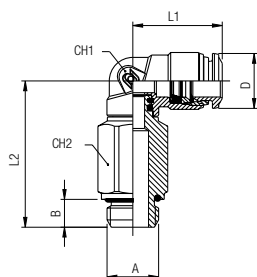

Code	Tube	A	B	L1	L2	CH1	CH2	D	Pack.
57126 00 001	4	1/8	5.5	18	30	9	12	10	10
57126 00 002	4	1/4	7	18	32	9	15	10	10
57126 00 003	5	1/8	5.5	20	34.5	11	12	12.5	10
57126 00 004	6	1/8	5.5	21	34.5	11	12	12.5	10
57126 00 005	6	1/4	7	21	36	11	15	12.5	10
57126 00 006	8	1/8	5	22.8	37.5	12	12	14.5	10
57126 00 007	8	1/4	7	22.5	38	12	15	14.5	10
57126 00 008	8	3/8	8	22.5	40	12	18	14.5	10
57126 00 009	10	1/4	7	26.5	45	14	16	17.5	10
57126 00 010	10	3/8	8	26.5	44.5	14	18	17.5	10

57130

New

RACCORDO A L INTERMEDIO

ELBOW CONNECTOR

WINKEL-ANSCHLUSS

RACCORD EQUERRE EGALE

RACOR A L INTERMEDIO

CONEXÃO EM "L" TUBO-TUBO

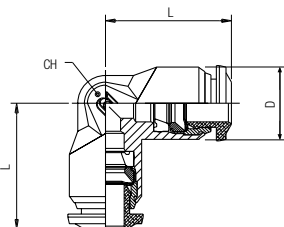

Code	Tube	L	CH	D	Pack.
* 57130 00 001	4 (5/32)	17	9	10	10
57130 00 006	5	20	11	12.5	10
57130 00 002	6	21	11	12.5	10
* 57130 00 003	8 (5/16)	22.5	13	14	10
57130 00 004	10	26.5	16	17	10
57130 00 005	12	30.5	19	21.5	10
57130 00 008	14	32.5	19	21.5	10
57130 00 009	16	33.5	19	24	10

57200

RACCORDO A T MASCHIO CONICO

TEE MALE ADAPTOR (TAPER) CENTRE LEG

T-EINSCHRAUBVERSCHRAUBUNG KONISCH (NICHT DREHBAR)

TÉ NON ORIENTABLE À PIQUAGE MÂLE CENTRAL, CONIQUE (COURT)

RACOR A T MACHO CENTRAL CÔNICO

CONEXÃO MACHO EM "T" ORIENTÁVEL COM ROSCA CÔNICA

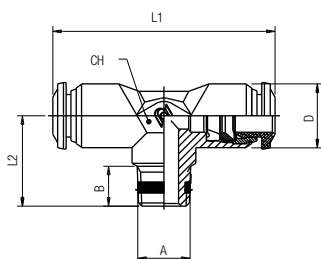

Code	Tube	A	B	L1	L2	CH	D	Pack.
57200 00 001	4	M5	5	34	15	9	10	10
57200 00 002	4	1/8	7.5	34	15.5	9	10	10
57200 00 010	5	1/8	7.5	40	17.5	11	12.5	10
57200 00 003	6	1/8	7.5	42	17.5	11	12.5	10
57200 00 004	8	1/8	7.5	45	19	13	14	10
57200 00 005	8	1/4	11	45	21.5	13	14	10
57200 00 006	10	1/4	11	53	24.5	16	17	10
57200 00 007	10	3/8	11.5	53	24	16	17	10
57200 00 008	12	1/4	11	61	28	19	21.5	10
57200 00 009	12	3/8	11.5	61	28	19	21.5	10

57211

New

RACCORDO A T ORIENTABILE MASCHIO "UNIVERSAL SHORT"

ORIENTING TEE MALE ADAPTOR "UNIVERSAL SHORT" - CENTRE LEG

T-EINSCHRAUBVERSCHRAUBUNG KONISCH (DREHBAR) "UNIVERSAL SHORT"

TÉ ORIENTABLE À PIQUAGE MÂLE CENTRAL, CONIQUE "UNIVERSAL SHORT"

RACOR A T ORIENTABLE MACHO CENTRAL CÔNICO "UNIVERSAL SHORT"

CONEXÃO EM "T" CENTRAL ORIENTÁVEL COM ROSCA MACHO "UNIVERSAL SHORT"

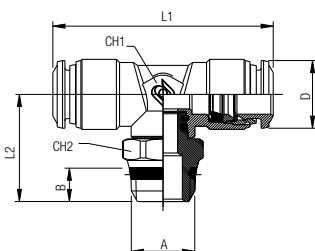

Code	Tube	A	B	L1	L2	CH1	CH2	D	Pack.
* 89211 00 003	4 (5/32)	1/8	5.5	34	20	9	13	10	10
* 89211 00 004	4 (5/32)	1/4	7	34	21.5	9	15	10	10
57211 00 004	6	1/8	5.5	42	22	11	13	12.5	10
57211 00 005	6	1/4	7	42	23.5	11	15	12.5	10
* 89211 00 016	8 (5/16)	1/8	5.5	45	25.5	13	13	14.5	10
* 89211 00 015	8 (5/16)	1/4	7	45	25.5	13	15	14.5	10
* 89211 00 017	8 (5/16)	3/8	7.5	45	26	13	17	14.5	10
57211 00 010	10	1/4	7	53	29	14	16	17.5	10
57211 00 011	10	3/8	7.5	53	27	14	17	17.5	10
57211 00 012	10	1/2	9	53	29.5	14	21	17.5	10
57211 00 013	12	3/8	7.5	62.5	29.5	16	20	21.5	10
57211 00 014	12	1/2	9	62.5	32	16	21	21.5	10
57211 00 017	16	3/8	7.5	66.5	41.5	19	25	24	10
57211 00 018	16	1/2	9	66.5	43	19	25	24	10

57216

New

RACCORDO A T ORIENTABILE MASCHIO CILINDRICO

ORIENTING TEE MALE ADAPTOR (PARALLEL) - CENTRE LEG

T-EINSCHRAUBVERSCHRAUBUNG ZYLINDRISCH (DREHBAR)

TÉ ORIENTABLE À PIQUAGE MÂLE CENTRAL, CYLINDRIQUE

RACOR A T ORIENTABLE MACHO CENTRAL CILÍNDRICO CON TÓRICA

CONEXÃO MACHO EM "T" ORIENTÁVEL COM ROSCA PARALELA

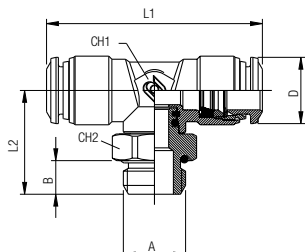

Code	Tube	A	B	L1	L2	CH1	CH2	D	Pack.
57216 00 002	4	M5	3.5	34	18	9	8	10	10
57216 00 003	4	1/8	5.5	34	18.5	9	13	10	10
57216 00 004	4	1/4	7	34	20	9	16	10	10
57216 00 005	5	M5	3.5	40	20.5	11	11	12.5	10
57216 00 006	5	1/8	5.5	40	20.5	11	13	12.5	10
57216 00 007	6	M5	3.5	42	20.5	11	11	12.5	10
57216 00 008	6	1/8	5.5	42	20.5	11	13	12.5	10
57216 00 009	6	1/4	7	42	22	11	16	12.5	10
57216 00 010	8	1/8	5.5	45	23.5	13	13	14.5	10
57216 00 011	8	1/4	7	45	24	13	16	14.5	10
57216 00 012	8	3/8	8	45	26	13	20	14.5	10
57216 00 013	8	1/2	9.5	45	27.5	13	25	14.5	10
57216 00 014	10	1/4	7	53	27.5	14	16	17.5	10
57216 00 015	10	3/8	8	53	27	14	20	17.5	10
57216 00 016	10	1/2	9.5	53	28.5	14	25	17.5	10
57216 00 017	12	3/8	8	62.5	29.5	16	20	21.5	10
57216 00 018	12	1/2	9.5	62.5	31	16	25	21.5	10
57216 00 019	14	3/8	8	62.5	29.5	16	20	21.5	10
57216 00 020	14	1/2	9.5	62.5	31	16	25	21.5	10
57216 00 025	16	3/8	8.1	66.5	40	19	25	24	10
57216 00 026	16	1/2	9.6	66.5	41.5	19	25	24	10
57216 00 021	6	M12x1	7.5	42	22	11	16	12.5	10
57216 00 022	6	M12x1.25	7.5	42	22	11	16	12.5	10
57216 00 023	6	M12x1.5	7.5	42	22	11	16	12.5	10

57223

RACCORDO A T ORIENTABILE MASCHIO LATERALE "UNIVERSAL SHORT"
 ORIENTING TEE MALE ADAPTOR "UNIVERSAL SHORT" OFF - SET LEG
 L-EINSCHRAUBVERSCHRAUBUNG KONISCH (DREHBAR) "UNIVERSAL SHORT"
 TÉ ORIENTABLE À PIQUAGE LATÉRAL, CONIQUE "UNIVERSAL SHORT"
 RACOR A T ORIENTABLE MACHO LATERAL CÓNICO "UNIVERSAL SHORT"
 CONEXÃO EM "T" LATERAL ORIENTÁVEL COM ROSCA MACHO "UNIVERSAL SHORT"

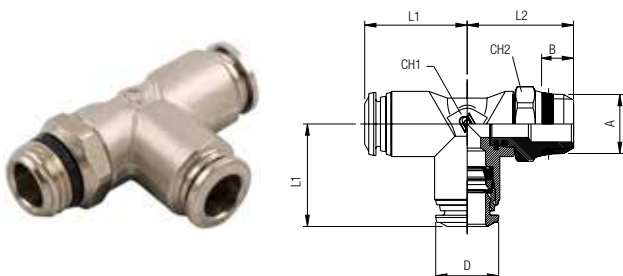

Code	Tube	A	B	L1	L2	CH1	CH2	D	Pack.
* 89223 00 003	4 (5/32)	1/8	5.5	17	20	9	13	10	10
* 89223 00 004	4 (5/32)	1/4	7	17	21.5	9	15	10	10
57223 00 004	6	1/8	5.5	21	22	11	13	12.5	10
57223 00 005	6	1/4	7	21	23.5	11	15	12.5	10
* 89223 00 015	8 (5/16)	1/8	5.5	22.5	24	13	13	14.5	10
* 89223 00 016	8 (5/16)	1/4	7	22.5	24	13	15	14.5	10
* 89223 00 017	8 (5/16)	3/8	7.5	22.5	27	13	17	14.5	10
57223 00 010	10	1/4	7	26.5	26	14	16	17.5	10
57223 00 011	10	3/8	7.5	26.5	26	14	17	17.5	10
57223 00 012	10	1/2	9	26.5	28.5	14	21	17.5	10
57223 00 013	12	3/8	7.5	31.5	29.5	16	20	21.5	10
57223 00 014	12	1/2	9	31.5	32	16	21	21.5	10

57226

RACCORDO A T ORIENTABILE MASCHIO LATERALE CILINDRICO
 ORIENTING TEE MALE ADAPTOR (PARALLEL) - OFF - SET LEG
 L-EINSCHRAUBVERSCHRAUBUNG ZYLINDRISCH (DREHBAR)
 TÉ ORIENTABLE À PIQUAGE LATÉRAL, CYLINDRIQUE
 RACOR A T ORIENTABLE MACHO LATERAL CILÍNDRICO CON TÓRICA
 CONEXÃO MACHO EM "T" LATERAL ORIENTÁVEL COM ROSCA PARALELA

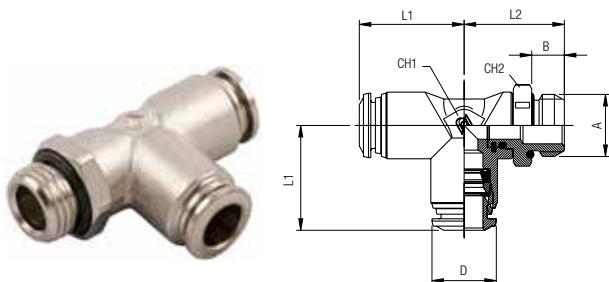

Code	Tube	A	B	L1	L2	CH1	CH2	D	Pack.
57226 00 002	4	M5	3.5	17	18	9	8	10	10
57226 00 003	4	1/8	5.5	17	18.5	9	13	10	10
57226 00 004	4	1/4	7	17	20	9	16	10	10
57226 00 005	5	M5	3.5	20	20.5	11	11	12.5	10
57226 00 006	5	1/8	5.5	20	20.5	11	13	12.5	10
57226 00 007	6	M5	3.5	21	20.5	11	11	12.5	10
57226 00 008	6	1/8	5.5	21	20.5	11	13	12.5	10
57226 00 009	6	1/4	7	21	22	11	16	12.5	10
57226 00 010	8	1/8	5.5	22.5	22.5	13	13	14.5	10
57226 00 011	8	1/4	7	22.5	23	13	16	14.5	10
57226 00 012	8	3/8	8	22.5	25	13	20	14.5	10
57226 00 013	8	1/2	9.5	22.5	26.5	13	25	14.5	10
57226 00 014	10	1/4	7	26.5	27	14	16	17.5	10
57226 00 015	10	3/8	8	26.5	26.5	14	20	17.5	10
57226 00 016	10	1/2	9.5	26.5	28	14	25	17.5	10
57226 00 017	12	3/8	8	31.5	29.5	16	20	21.5	10
57226 00 018	12	1/2	9.5	31.5	31	16	25	21.5	10
57226 00 021	6	M12x1	7.5	21	22	11	16	12.5	10
57226 00 022	6	M12x1.25	7.5	21	22	11	16	12.5	10
57226 00 023	6	M12x1.5	7.5	21	22	11	16	12.5	10

57230

RACCORDO A T INTERMEDIO
 TEE CONNECTOR
 T-ANSCHLUSS
 RACCORD TÉ
 RACOR A T INTERMEDIO
 CONEXÃO EM "T" TUBO-TUBO

New

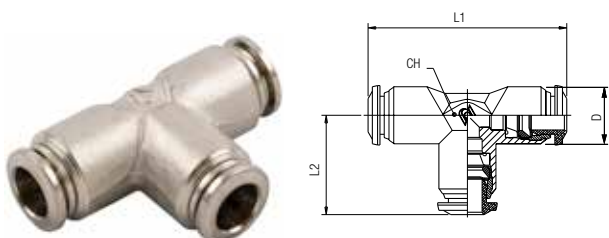

Code	Tube	L1	L2	CH	D	Pack.
* 57230 00 001	4 (5/32)	34	17	9	10	10
57230 00 006	5	40	20	11	12.5	10
57230 00 002	6	42	21	11	12.5	10
* 57230 00 003	8 (5/16)	45	22.5	13	14	10
57230 00 004	10	53	26.5	16	17	10
57230 00 005	12	61	30.5	19	21.5	10
57230 00 008	14	65.5	32.5	19	21.5	10
57230 00 010	16	66.5	33	19	24	10

57310

RACCORDO A Y INTERMEDIO
 Y CONNECTOR
 Y-ANSCHLUSS
 RACCORD Y SIMPLE
 RACOR A Y INTERMEDIO
 CONEXÃO EM "Y" TUBO-TUBO

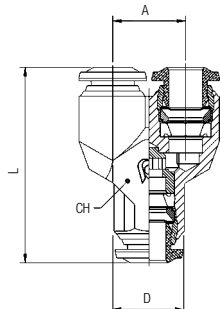

Code	Tube	A	L	CH	D	Pack.
* 57310 00 001	4 (5/32)	11	32	11	10	10
57310 00 004	5	13.5	35	13	12.5	10
57310 00 002	6	13.5	36.5	13	12.5	10
* 57310 00 003	8 (5/16)	15.5	41	15	14	10
57310 00 008	10	18.5	48	18	17	10

57326

RACCORDO A Y ORIENTABILE MASCHIO CILINDRICO
 Y CONNECTOR MALE ADAPTOR (PARALLEL)
 Y-ANSCHLUSS ZYLINDRISCH (DREHBAR)
 RACCORD Y SIMPLE MÂLE, CYLINDRIQUE
 RACOR A Y ORIENTABLE MACHO CILÍNDRICO CON TÓRICA
 CONEXÃO MACHO EM "Y" ORIENTÁVEL COM ROSCA PARALELA

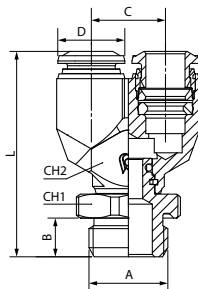

Code	Tube	A	B	C	CH1	CH2	D	Pack.
57326 00 003	4	1/8	5.5	32.5	13	11	10	10
57326 00 008	6	1/8	5.5	37	13	13	12.5	10
57326 00 009	6	1/4	7	38.5	16	13	12.5	10
57326 00 010	8	1/8	5.5	40.5	13	15	14	10
57326 00 011	8	1/4	7	41	16	15	14	10
70326 00 012	8	3/8	8	43	20	15	14	10

57500

ANELLO A L ORIENTABILE
 SINGLE BANJO BODY
 RINGANSCHLUSS
 CORPS SIMPLE POUR BANJO
 ANILLO ORIENTABLE SIMPLE
 ANEL ORIENTÁVEL EM "L"

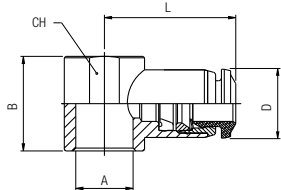

Code	Tube	A	B	L	CH	D	Pack.
* 57500 00 001	4 (5/32) M5(10/32)	12.5	19	-	10	10	
57500 00 002	4 M6	12.5	19	-	10	10	
* 57500 00 003	4 (5/32) 1/8	15	21	14	10	10	
57500 00 013	5 M5	12.5	20	-	12.5	10	
57500 00 017	5 M6	12.5	20	-	12.5	10	
57500 00 014	5 1/8	15	21.5	14	12.5	10	
57500 00 015	5 1/4	17	24.5	18	12.5	10	
57500 00 016	6 M5	12.5	20.5	-	12.5	10	
57500 00 018	6 M6	12.5	20.5	-	12.5	10	
57500 00 004	6 1/8	15	22	14	12.5	10	
57500 00 005	6 1/4	17	25	18	12.5	10	
* 57500 00 006	8 (5/16) 1/8	15	24	14	14	10	
* 57500 00 007	8 (5/16) 1/4	17	26	18	14	10	
* 57500 00 008	8 (5/16) 3/8	20	28	21	14	10	
57500 00 009	10 1/4	17	29	18	17	10	
57500 00 010	10 3/8	20	30.5	21	17	10	
57500 00 012	12 3/8	20	32.5	21	21.5	10	
57500 00 021	12 1/2	24	35	25	21.5	10	
57500 00 022	14 1/2	24	35.5	25	21.5	10	

57510

ANELLO A T ORIENTABILE
 DOUBLE BANJO BODY
 DOPPELTER RINGANSCHLUSS
 CORPS DOUBLE POUR BANJO
 ANILLO ORIENTABLE DOBLE
 ANEL ORIENTÁVEL EM "T"

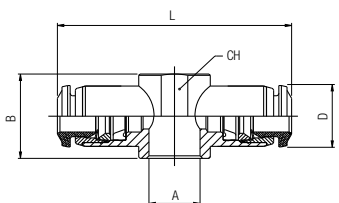

Code	Tube	A	B	L	CH	D	Pack.
* 57510 00 001	4 (5/32) M5	12.5	38	-	10	10	
* 57510 00 002	4 (5/32) M6	12.5	38	-	10	10	
* 57510 00 003	4 (5/32) 1/8	15	42	14	10	10	
57510 00 008	5 1/8	15	43	14	12.5	10	
57510 00 009	5 1/4	17	49	18	12.5	10	
57510 00 004	6 1/8	15	44	14	12.5	10	
57510 00 005	6 1/4	17	50	18	12.5	10	
* 57510 00 006	8 (5/16) 1/8	15	48	14	14	10	
* 57510 00 007	8 (5/16) 1/4	17	52	18	14	10	

57550

RACCORDO A L ORIENTABILE MASCHIO CILINDRICO

ORIENTING SINGLE BANJO BODY MALE
 WINKELSCHWENKVERSCHRAUBUNG ZYLINDRISCH (DREHBAR)
 EQUERRE MÂLE BANJO, ORIENTABLE
 RACOR ORIENTABLE SIMPLE CON TÓRICA
 CONEXÃO BANJO EM "L" COM ROSCA PARALELA

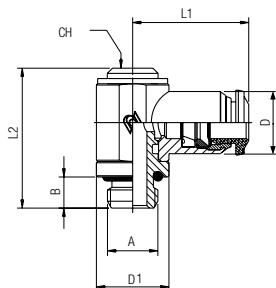

Code	Tube	A	B	L1	L2	CH	D1	D	Pack.
57550 00 001	4	M5	3.6	19	24.5	-	CH8	10	10
57550 00 002	4	1/8	6	21	28	5	14	10	10
57550 00 012	5	M5	3.6	20	24.5	-	CH8	12.5	10
57550 00 013	5	1/8	6	21.5	28	5	14	12.5	10
57550 00 014	5	1/4	8	24.5	31	6	17	12.5	10
57550 00 015	6	M5	3.6	20.5	24.5	-	CH8	12.5	10
57550 00 003	6	1/8	6	22.5	28	5	14	12.5	10
57550 00 004	6	1/4	8	25	31	6	17	12.5	10
57550 00 005	8	1/8	6	24	28	5	14	14	10
57550 00 006	8	1/4	8	26	31	6	17	14	10
57550 00 007	8	3/8	9	28	35.5	7	20	14	10
57550 00 008	10	1/4	8	29	31	6	17	17	10
57550 00 009	10	3/8	9	30.5	35.5	7	20	17	10
57550 00 011	12	3/8	9	32.5	35.5	7	20	21.5	10

57560

RACCORDO A T ORIENTABILE MASCHIO CILINDRICO

ORIENTING DOUBLE BANJO BODY MALE
 T-SCHWENKVERSCHRAUBUNG ZYLINDRISCH (DREHBAR)
 TÉ MÂLE BANJO, ORIENTABLE
 RACOR ORIENTABLE DOBLE CON TÓRICA
 CONEXÃO BANJO EM "T" ORIENTÁVEL COM ROSCA PARALELA

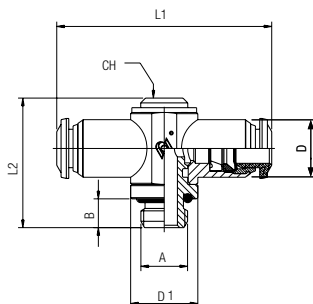

Code	Tube	A	B	L1	L2	D1	CH	D	Pack.
57560 00 002	4	1/8	6	42	27	14	5	10	10
57560 00 008	5	1/8	6	43	27	14	5	12.5	10
57560 00 009	5	1/4	8	49	31	17	6	12.5	10
57560 00 003	6	1/8	6	45	27	14	5	12.5	10
57560 00 004	6	1/4	8	50	31	17	6	12.5	10
57560 00 005	8	1/8	6	48	27	14	5	14	10
57560 00 006	8	1/4	8	52	31	17	6	14	10

51410

VITE CAVA SINGOLA

BANJO STEM SINGLE
 EINFACHE HOHLSCHRAUBE
 VIS POUR BANJO SIMPLE
 TORNILLO SIMPLE
 HASTE PARA CONEXÃO BANJO COM 1 CAVIDADE

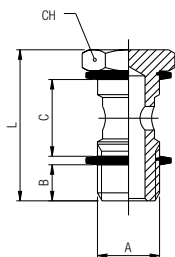

Code	A	B	C	L	CH	Pack.
51410 00 011	M5	4	12.5	22	8	10
51410 00 012	M6	5	12.5	23	8	10
51410 00 013	1/8	6	15	28	14	10
51410 00 014	1/4	8	17	32	17	10
51410 00 015	3/8	9	20	36	19	10
51410 00 016	1/2	10	24	42	24	10
51410 00 017	*M12x1.5	8	17	32	17	10

Questo articolo viene fornito completo di rondelle in PA66 (ART. 1610).

This item will be supplied with the PA66 washers (ART. 1610).

Dieser artikel wird mit dichtungsen aus PA66 (ART. 1610) Mitgeliefert.

Livré avec joints en PA66 (ART. 1610).

Este artículo viene completo de arandelas en nylon (ART. 1610).

Este item vem acompanhado de arruelas em PA66 (CÓD. 1610).

* Con questa vite utilizzare gli anelli orientabili da 1/4.

* With this banjo stem using 1/4 orienting banjo body.

* Bei dieser größe können dichterunge für 1/4 eingesetzt werden.

* Compatible avec joint 1/4.

* Con este tornillo utilizar el anillo orientable de 1/4.

* Com esta haste para banjo utilizar os anéis orientáveis de 1/4.

51420

VITE CAVA DOPPIA

BANJO STEM DOUBLE
DOPPELTE HOHLSCHRAUBE
VIS POUR BANJO DOUBLE
TORNILLO DOBLE
HASTE PARA CONEXÃO BANJO COM 2 CAVIDADES

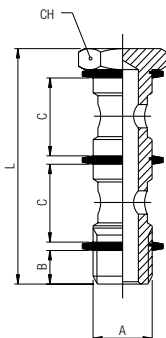

Code	A	B	C	L	CH	Pack.
51420 00 011	1/8	6	15	44.5	14	10
51420 00 012	1/4	8	17	50.5	17	10
51420 00 013	3/8	9	20	58	19	10
51420 00 014	1/2	10	24	68	24	10
51420 00 015	*M12x1.5	8	17	50.5	17	10

Questo articolo viene fornito completo di rondelle in PA66 (ART. 1610).
This item will be supplied with the PA66 washers (ART. 1610).
Dieser artikel wird mit dichtungen aus PA66 (ART. 1610) Mitgeliefert.
Livré avec joints en PA66 (ART. 1610).
Este artículo viene completo de arandelas en nylon (ART. 1610).
Este item vem acompanhado de arruelas em PA66 (CÓD. 1610).

- * Con questa vite utilizzare gli anelli orientabili da 1/4.
- * With this banjo stem using 1/4 orienting banjo body.
- * Bei dieser größe können dichtringe für 1/4 eingesetzt werden.
- * Compatible avec joint 1/4.
- * Con este tornillo utilizar el anillo orientable de 1/4.
- * Com esta haste para banjo utilizar os anéis orientáveis de 1/4.

51430

VITE CAVA TRIPLA

BANJO STEM TRIPLE
DREIFACH HOHLSCHRAUBE
VIS POUR BANJO TRIPLE
TORNILLO TRIPLE
HASTE PARA CONEXÃO BANJO COM 3 CAVIDADES

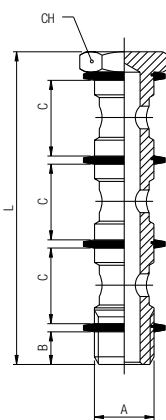

Code	A	B	C	L	CH	Pack.
51430 00 011	1/8	6	15	61	14	10
51430 00 012	1/4	8	17	69	17	10
51430 00 013	3/8	9	20	80	19	10
51430 00 014	1/2	10	24	94	24	10

Questo articolo viene fornito completo di rondelle in PA66 (ART. 1610).
This item will be supplied with the PA66 washers (ART. 1610).
Dieser artikel wird mit dichtungen aus PA66 (ART. 1610) Mitgeliefert.
Livré avec joints en PA66 (ART. 1610).
Este artículo viene completo de arandelas en nylon (ART. 1610).
Este item vem acompanhado de arruelas em PA66 (CÓD. 1610).

51440

VITE CAVA SINGOLA MASCHIO - FEMMINA

MALE - FEMALE BANJO STEM SINGLE
AUFSCRAUBHOHLSCHRAUBE MIT INNENGEWINDE
VIS CREUSE TARAUDÉE POUR BANJO SIMPLE
TORNILLO SIMPLE MACHO - HEMBRA
HASTE PARA CONEXÃO BANJO COM 1 CAVIDADE MACHO - FÊMEA

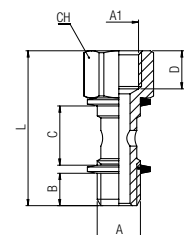

Code	A	A1	B	C	D	L	CH	Pack.
51440 00 001	1/8	1/8	6	15	8.5	34.5	14	10
51440 00 002	1/4	1/4	8	17	11	40.5	17	10
51440 00 003	3/8	3/8	9	20	12	45.5	19	10

Questo articolo viene fornito completo di rondelle in PA66 (ART. 1610).
This item will be supplied with the PA66 washers (ART. 1610).
Dieser artikel wird mit dichtungen aus PA66 (ART. 1610) Mitgeliefert.
Livré avec joints en PA66 (ART. 1610).
Este artículo viene completo de arandelas en nylon (ART. 1610).
Este item vem acompanhado de arruelas em PA66 (CÓD. 1610).

50600

ADATTATORE MASCHIO CILINDRICO

MALE ADAPTOR PARALLEL
EINSCHRAUBSTECKVERSCHRAUBUNG ZYLINDRISCH
ADAPTATEUR ENCLIQUETABLE MÂLE, CYLINDRIQUE
ADAPTADOR MACHO CILÍNDRICO CON TÓRICA
ADAPTADOR MACHO COM ROSCA PARALELA

New

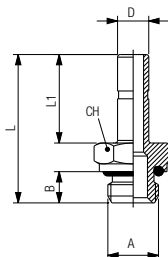

Code	D	A	B	L	L1	CH	Pack.
50600 00 001	4	M5	4	24	15	8	10
50600 00 002	4	1/8	6	26.5	15	13	10
50600 00 012	5	M5	4	26	17	8	10
50600 00 013	5	1/8	6	28.5	17	13	10
50600 00 014	5	1/4	8	31	17	16	10
50600 00 015	6	M5	4	26	17	8	10
50600 00 003	6	1/8	6	28.5	17	13	10
50600 00 004	6	1/4	8	31	17	16	10
50600 00 005	8	1/8	6	29.5	18	13	10
50600 00 006	8	1/4	8	32	18	16	10
50600 00 007	8	3/8	9	33.5	18	20	10
50600 00 016	10	1/8	6	33.5	22	13	10
50600 00 008	10	1/4	8	36	22	16	10
50600 00 009	10	3/8	9	37.5	22	20	10
50600 00 017	10	1/2	10	39.5	22	24	10
50600 00 010	12	1/4	8	38.5	24.5	16	10
50600 00 011	12	3/8	9	40	24.5	20	10
50600 00 018	14	1/2	10	44	26.5	24	10

57610

TAPPO

PLUG
VERSCHLUSSZAPFEN
BOUCHON ENCLIQUETABLE
TAPÓN
TAMPÃO

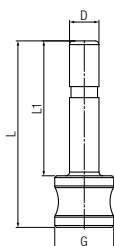

Code	D	G	L	L1	Pack.
* 57610 00 01 X1 NB 4 (5/32)	8		25.5	18.5	10
57610 00 01 X3 NB 5	5	8	27	20	10
57610 00 01 X4 NB 6	6	8	27.5	20.5	10
* 57610 00 01 X7 NB 8 (5/16)	12		29.5	21.5	10
57610 00 01 X9 NB 10	10	12	32.5	24.5	10
57610 00 01 Y1 NB 12	12	16	36.5	27.5	10
57610 00 01 Y3 NB 14	14	16	35.5	26.5	10

50625

GIUNZIONE DOPPIA

DOUBLE JOINT
DOPPELSTECKER
JONCTION DOUBLE
UNIÓN DOBLE
JUNÇÃO DUPLA

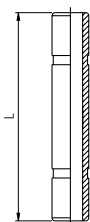

Code	Tube	L	Pack.
* 50625 00 01 X1 NB 4 (5/32)		31	10
50625 00 01 X3 NB 5	5	33	10
50625 00 01 X4 NB 6	6	34	10
* 50625 00 01 X7 NB 8 (5/16)	8	36	10
50625 00 01 X9 NB 10	10	45	10
50625 00 01 Y1 NB 12	12	50	10

57700

RIDUZIONE

REDUCER
REDUZIERUNG
RÉDUCTION ENCLIQUETABLE
REDUCCIÓN
REDUÇÃO

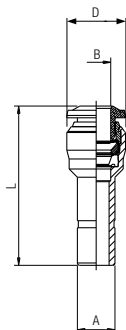

New

Code	A	B	L	D	Pack.
57700 00 004	5	4	29	10.5	10
57700 00 001	6	4	30	10.5	10
57700 00 005	6	5	32	11.5	10
* 57700 00 008 8 (5/16) 4 (5/32)	8	4	33	10.5	10
57700 00 002	8	6	34	14	10
57700 00 009	10	4	32	10	10
57700 00 011	10	6	37.5	12.5	10
57700 00 003	10	8	38	14.5	10
57700 00 007	12	8	39	14.5	10
57700 00 010	12	10	43	17.5	10

57800

CARTUCCE A COMPRESIONE

PUSH-FIT CARTRIDGES
EINPRESSPATRONEN
CARTOUCHE
CARTUCHO A COMPRESIÓN
CARTUCHO DE COMPRESSÃO

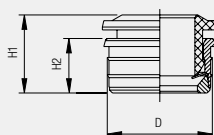

Code	Tube	D	H1	H2	Pack.
57800 00 001	4	8.7	10.4	5.6	25
57800 00 002	5	9.75	11.8	6.3	25
57800 00 003	6	10.75	12.4	6.9	25
57800 00 004	8	12.7	12.4	6.9	25
57800 00 005	10	15.7	15.7	8.5	25
57800 00 006	12	18.3	17.8	9.5	25

Dimensioni sedi cartucce a compressione.

Seats dimensions push-fit cartridges.

Bohrungsangaben für die einpresspatronen.

Dimensions des logements des cartouches.

Dimensiones sede cartucho a compresión.

Dimensão da sede do cartucho de compressão.

SEDE

SEAT
BOHRUNGEN
IMPLANTATION
SEDE
SEDE

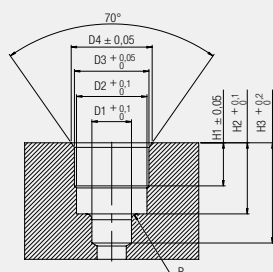

Tube	D1	D2	D3	D4	H1	H2	H3	R
4	4.2	7.45	8.4	9	3.75	6.5	9.5	0.5
5	5.2	8.35	9.4	10.15	4.45	7.9	10.5	0.5
6	6.2	9.35	10.45	11.35	5	8.5	11.5	0.5
8	8.2	11.4	12.4	12.9	5.2	8.5	12.5	0.75
10	10.2	14.5	15.4	16	6.7	10.5	15	0.75
12	12.2	17	18	19	7.5	12.1	17	1

55801

FRESA SEDE CARTUCCE A COMPRESSIONE

TOOL FOR PUSH-FIT CARTRIDGES SEAT
 STUFENBOHRER FÜR EINPRESSPATRONEN
 OUTIL DE PERÇAGE POUR CARTOUCHE
 FRESA SEDE CARTUCHO A COMPRESIÓN
 FRESA PARA FURAÇÃO DA SEDE DO CARTUCHO DE COMPRESSÃO



Code	Tube	ø Body	Pack.
55801 00 001	4	10	1
55801 00 006	5	12	1
55801 00 002	6	12	1
55801 00 003	8	12	1
55801 00 004	10	16	1
55801 00 005	12	16	1

55802

CANOTTO MONTAGGIO CARTUCCE A COMPRESSIONE

ASSEMBLING TOOL FOR PUSH-FIT CARTRIDGES
 MONTAGEWERKZEUG FÜR EINPRESSPATRONEN
 OUTIL DE MONTAGE POUR CARTOUCHE
 ÚTIL DE MONTAJE CARTUCHO A COMPRESIÓN
 TUBETE PARA MONTAGEM DO CARTUCHO DE COMPRESSÃO



Code	Tube	Pack.
55802 00 002	4	1
55802 00 003	5	1
55802 00 004	6	1
55802 00 005	8	1
55802 00 006	10	1
55802 00 007	12	1

ISTRUZIONI DI MONTAGGIO CARTUCCE A COMPRESSIONE ART. 55800

PUSH-FIT CARTRIDGES ASSEMBLING INSTRUCTIONS ART. 55800

ANLEITUNG FÜR DIE MONTAGE DER EINPRESSPATRONEN ART. 55800

INSTRUCTION DE MONTAGE POUR CARTOUCHE RÉF. 55800

INSTRUCCIONES DE MONTAJE CARTUCHO A COMPRESIÓN ART. 55800

INSTRUÇÕES DE MONTAGEM DO CARTUCHO DE COMPRESSÃO CÓD. 55800

1

Realizzare la sede per la cartuccia utilizzando l'apposita fresa Art. 55801.

Make the seat for the cartridge utilizing the suitable tool Art. 55801.

Machen sie die Sitze für die Einpresspatronen mit dem entsprechenden Stufenbohrer Art. 55801.

Usiner le logement de la cartouche à l'aide de l'outil de perçage réf. 55801.

Realizar la sede para el cartucho utilizando la correspondiente fresa Art. 55801.

Realize a furação da sede para o cartucho utilizando a fresa de cód. 55801.



2

Inserire la guarnizione sagomata nell'apposita sede.

Insert the seal inside of the seat.

Legen sie die dichtung in die Bohrung ein.

Insérer le joint dans le logement.

Insertar la junta en la correspondiente sede.

Insira vedação no fundo da sede.



3

Inserire la cartuccia nel canotto di montaggio Art. 55802.

Insert the cartridge into the assembling tool Art. 55802.

Legen sie die Einpresspatrone in das Montage-werkzeug Art. 55802.

Insérer la cartouche dans l'outil de montage réf. 55802.

Insertar el cartucho en el útil de montaje Art. 55802.

Insira o cartucho no tubete de montagem Cód. 55802.



4

Premere la cartuccia all'interno della sede fino ad arrivare in battuta sul piano con il canotto.

Press the cartridge inside of the seat until it will be reached the abutment surface with the assembling tool.

Drücken sie die Einpresspatrone in die Bohrung, bis das Montage-werkzeug am Werkstück ansteht.

Presser la cartouche dans le logement jusqu'à ce que l'outil de montage soit en contact avec la surface.

Empujar el cartucho al interior de la sede hasta llegar al plano con el útil de montaje.

Pressione o cartucho no interior da sede até tocar a superfície de montagem com o tubete.



50980

CLIP DI SICUREZZA

SECURITY CLIPS
SICHERHEITSClip
CLIP DE SECURITÉ
CLIP DE SEGURIDAD ROJO
CLIP DE SEGURANÇA

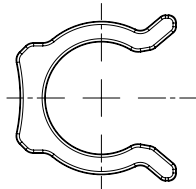

Code	Tube	Pack.
50980 00 32 X1 RO	4 (5/32)	50
50980 00 32 X3 RO	5	50
50980 00 32 X4 RO	6 (1/4)	50
50980 00 32 X7 RO	8 (5/16)	50
50980 00 32 X9 RO	10 (3/8)	50
50980 00 32 Y1 RO	12 (1/2)	50
50980 00 32 Y3 RO	14	50

50990

LEVA SGANCIO ADATTATORI

TOOL FOR DISASSEMBLING
LÖSEWERKZEUG
OUTIL DE DÉMONTAGE
LLAVE DE DESMONTAJE
FERRAMENTA PARA DESMONTAGEM

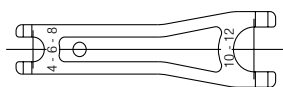

Code	Pack.
50990 00 001	10

50006

ANELLO DI TENUTA PER FILETTI CONICI "UNIVERSAL SHORT"

THREAD PACKING FOR THE "UNIVERSAL SHORT" TAPER THREADS
DICHTRINGE FÜR KONISCHE GEWINDE "UNIVERSAL SHORT"
BAGUE D'ÉTANCHÉITÉ POUR FILETAGES CONIQUES "UNIVERSAL SHORT"
JUNTA DE CIERRE PARA ROSCAS CÓNICAS "UNIVERSAL SHORT"
ANEL DE VEDAÇÃO PARA ROSCAS CÔNICA "UNIVERSAL SHORT"



Code	Thread	Pack.
50006 00 24 02 00	1/8	10
50006 00 24 03 00	1/4	10
50006 00 24 04 00	3/8	10
50006 00 24 05 00	1/2	10

